

FACTORY

Jl. Bangun Mulia No. 43 Dusun VII,
Desa Puji Mulyo - Sunggal, Deli Serdang,
Medan, Sumatera Utara
Tel. 0852 12180988

JAKARTA WAREHOUSE

Pergudangan Era Prima
Jl. Daan Mogot Km. 21 No. 1 Blok. G15
Batu Ceper, Tangerang
Tel. (021) 29516275 / 0852 81145116

SURABAYA WAREHOUSE

Pergudangan Akses Kebomas Blok E No. 52-55,
Blok F No.28Jl. Mayjen Sungkono No.38 Gresik,
Jawa Timur
Tel. (031) 39923343 / 0852 87194656

MAKASSAR WAREHOUSE

Jl. Prof Ir. Sutami, Pergudangan Lantebung
Blok. B2 no. 11, Makassar
Tel. 0819 18994813

BALIKPAPAN WAREHOUSE

Jl. AMD Projakal Pergudangan Bizhub 52, Blok D No.21
Kariangau, Balikpapan - Kalimantan Timur
Tel. 0819 3320 2555 / 0822 7297 0055

LAMPUNG WAREHOUSE

Jl.Slamet Riyadi No.38 Teluk Betung, Bumi Waras,
Bandar Lampung, Lampung 35226,
Tel. 0823 79332155

PADANG WAREHOUSE

Jl.Raya Bandar Buat No.25A, Bandar Buat,
Lubuk Kilangan, Kota Padang, Sumatera Barat 25231
Tel. 0812 63111214



www.kartindorubber.com



Building A Network Of Trust

PRODUCT
CATALOGUE

2025 / 2026



MS-ISO 9001:2015 No. Reg. 60606



COMPANY PROFILE



TYRE RETREADING SOLUTION

Meet the needs of successful fleet

No worries, Profits assured. All tread designs and formulations are developed with performance, reliability and sustainability in mind. By using our products, fleet owners can be assured that we strive tirelessly to ensure minimal downtime for fleet owners and maximize return of investment for every kilometers travelled.

SOLUSI BAN VULKANISIR

Memenuhi kebutuhan perusahaan pengangkutan dengan sukses

Tiada khawatir, untung terjamin. Semua pembaharuan design tapak dan resep dikembangkan dengan memastikan kinerja, handal dan berjangka panjang. Dengan memakai produk kami, pemilik pengangkutan akan mendapat waktu mogok yang minimal dan balik modal investasi yang maksimal.

PT Sumatera Kartindo was founded in the year 1990. Since then, we have established ourselves as a rubber compound specialist, renowned for supplying customized black rubber compounds and materials for quality oriented customers in the tyre retread industry.

To ensure our customers can reap the full benefits of our products and materials for their sustainable growth, we are committed to support their business in the following ways:

- 1) Collaborative and constant support in our sales and marketing.
- 2) Thermocouple and other technical support.
- 3) Our focused investments and upgrading to cater to the evolving market demands.

Ultimately, we strive for continuous product improvements, process innovations and loyalty to our stakeholders.

Profil Perusahaan

PT Sumatera Kartindo didirikan pada tahun 1990. Sejak itu, kami telah membangun perusahaan sebagai spesialis karet compound, terutama karet compound hitam dan bahan baku untuk pelanggan berkualitas di industri ban vulkanisir

Untuk memastikan pelanggan kami bisa menuai keuntungan dari produk bahan baku dan bisa mempertahankan pertumbuhan perusahaan mereka, kami berkomitmen untuk mendukung usaha mereka dengan beberapa upaya berikut:

- 1) Kolaborasi dan dukungan yang berkesinambungan dari segi sales dan marketing.
- 2) Dukungan thermocouple test dan dukungan teknis lain.
- 3) Investasi dan peningkatan perusahaan kami yang berfokus dan sesuai dengan permintaan pasar yang terus menerus berubah.

Pada akhirnya, kami berusaha keras untuk meningkatkan perbaikan produk yang berkesinambungan, inovasi proses dan kesetiaan terhadap para stakeholders kami.



SPECIALIZED RUBBER SOLUTION

Meeting the strenuous demands and specific standards of leading global manufacturers

Your needs, Our deeds. Using our updated technology, we tailor our formulations and mixing procedures to meet stringent requirements and expectations across various industries.

SOLUSI KARET TEKNIS SPECIAL

Memenuhi standard tinggi dan keperluan spesifik para pengusaha pengusaha pabrik global

Keperluan anda, upaya kami. Dengan memakai teknologi terkini, kami menyesuaikan resep dan proses pencampuran karet untuk memenuhi keperluan, syarat syarat dan ekspetasi di berbagai macam industri yang ketat.



ONE-STOP-SOLUTION CENTRE

Great products and high reliability compliments each other





We source, We deliver. Every dollar and cent counts! Our robust technical team also support our customers through obtaining the best and affordable tyre retread tools, accessories and machineries which offer high efficiency and uncompromised reliability.



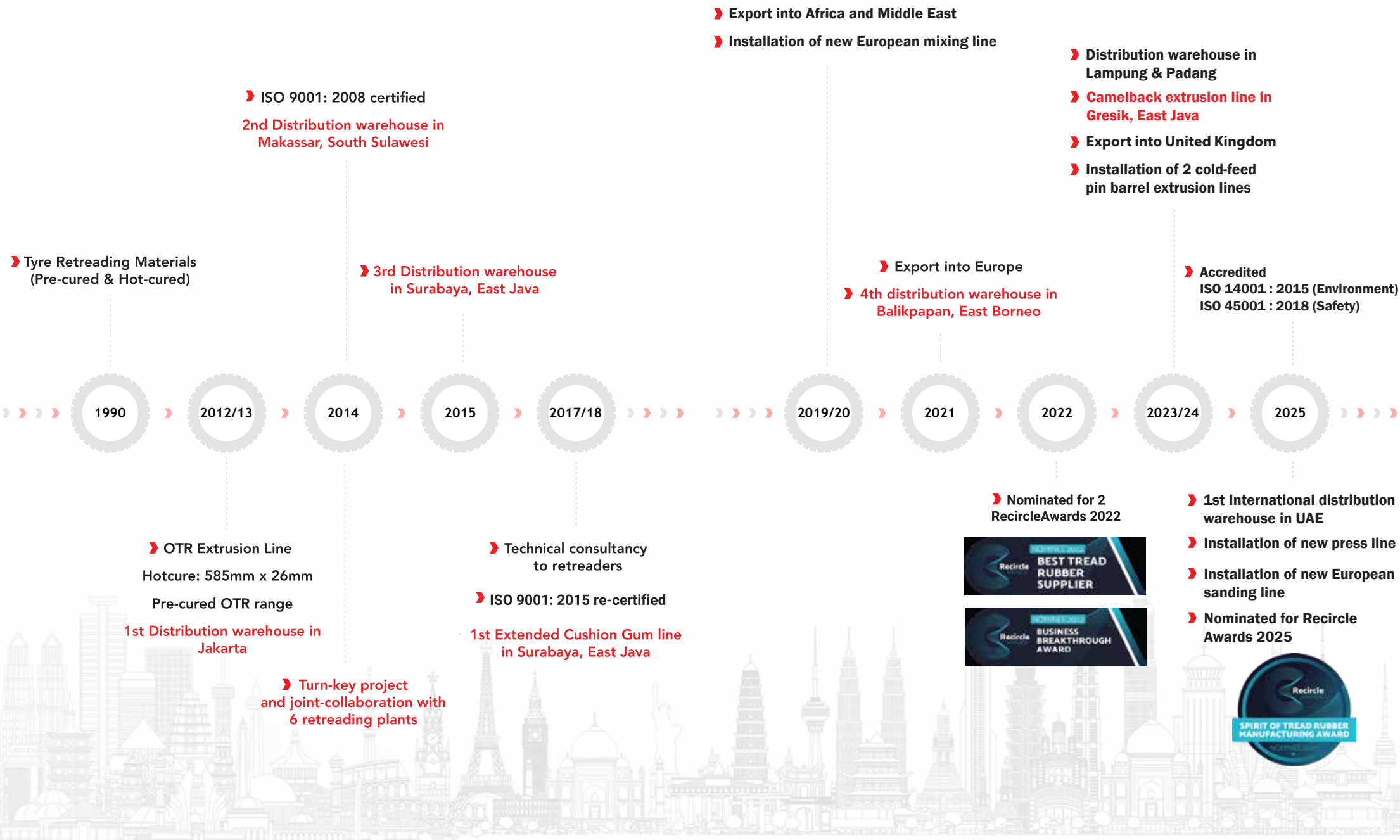

PUSAT ONE-STOP-SOLUSI

Produk unggul itu bergantung dengan kehandalan yang tinggi





Karya kami, pengantaran kami. Setiap peser biaya itu bermakna! Tim teknis kami yang berbobot juga memberi dukungan ke pelanggan dengan menyediakan perkakas, aksesori dan mesin mesin vulkanisir dengan harga terjangkau, yang berefisiensi dan pengendalian yang tiada kompromi.



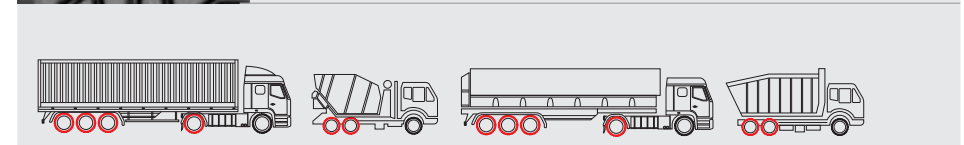
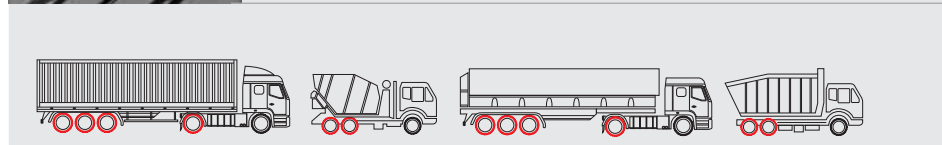



AS	Pattern Code	 (mm)	 (mm)	 (mm)	 (kg/roll)	 (kg/m)
	AS150	150	12	4840	9.55	1.97
AS180	180	14	3040	7.80	2.57	
AS193	193	14	3170	8.80	2.78	
AS205	205	15	3230	10.25	3.17	

AT	Pattern Code	 (mm)	 (mm)	 (mm)	 (kg/roll)	 (kg/m)
	AT150	150	13	4825	10.00	2.07
AT160	160	13	2675	5.80	2.17	
AT194	194	15	3215	9.56	2.97	





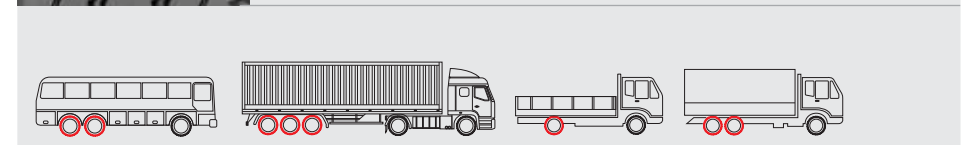

HB	Pattern Code	 (mm)	 (mm)	 (mm)	 (kg/roll)	 (kg/m)
	HB150	150	11	4840	9.55	1.97
HB160	160	11	2650	5.64	2.13	
HB180	180	13	3080	8.92	2.90	
HB193	193	14	3167	10.10	3.18	
HB205	205	14	3245	11.15	3.44	
HB210	210	15	3300	12.54	3.80	





HW	Pattern Code	 (mm)	 (mm)	 (mm)	 (kg/roll)	 (kg/m)
	HW140	140	11	4690	8.86	1.89
HW150	150	12	4830	10.07	2.08	
HW193	193	16	3190	11.30	3.54	



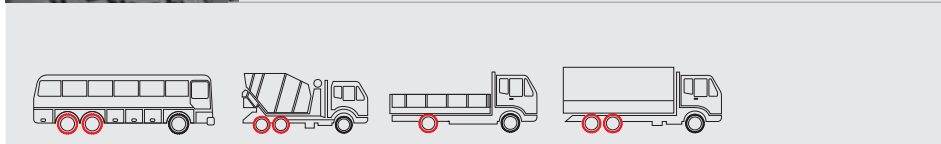



K	Pattern Code					
		(mm)	(mm)	(mm)	(kg/roll)	(kg/m)
	K110	110	9	4990	5.80	1.16
	K127	127	10	4990	7.10	1.42
	K140	140	11	4675	8.70	1.86
	K150	150	12	4860	10.56	2.17
	K180	180	14	3070	8.70	2.83
	K193	193	15	3200	10.35	3.23





KA	Pattern Code					
		(mm)	(mm)	(mm)	(kg/roll)	(kg/m)
	KA150	150	12	4820	10.00	2.07
	KA193	193	15	3170	10.20	3.22



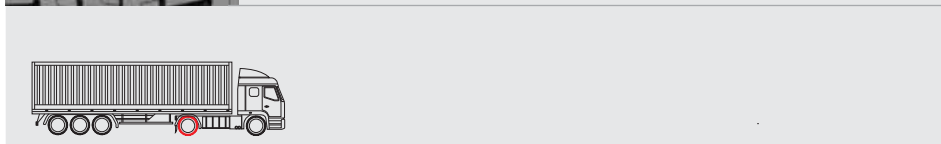



KB	Pattern Code					
		(mm)	(mm)	(mm)	(kg/roll)	(kg/m)
	KB193	193	15	3140	10.00	3.18





KAC	Pattern Code					
		(mm)	(mm)	(mm)	(kg/roll)	(kg/m)
	KAC152	152	12	4810	9.80	2.04







KAB	Pattern Code	 (mm)	 (mm)	 (mm)	 (kg/roll)	 (kg/m)
	KAB152	152	13	4860	9.20	1.89
	KAB170	170	13	2555	5.60	2.17
	KAB194	194	15	3365	9.00	2.64
	KAB210	210	17	3304	11.20	3.39
	KAB230	230	22	3802	19.00	5.00





KES	Pattern Code	 (mm)	 (mm)	 (mm)	 (kg/roll)	 (kg/m)
	KES193	193	14	3190	9.15	2.87



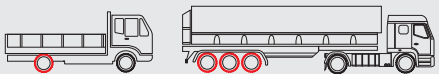

KBA	Pattern Code	 (mm)	 (mm)	 (mm)	 (kg/roll)	 (kg/m)
	KBA150	150	11	4840	9.70	2.00
	KBA160	160	13	2675	6.21	2.32

KES 29	Pattern Code	 (mm)	 (mm)	 (mm)	 (kg/roll)	 (kg/m)
	KES 29 150	150	11	4860	9.50	1.95



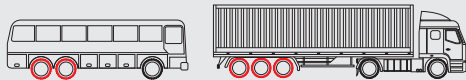



KFC	Pattern Code					
		(mm)	(mm)	(mm)	(kg/roll)	(kg/m)
	KFC150	150	11	4850	9.45	1.95
	KFC196	196	15	3220	10.46	3.25
	KFC210	210	15	3280	11.40	3.40
	KFC220	220	16	3290	12.00	3.66
	KFC230	230	16	3310	13.97	4.22
	KFC240	240	16	3320	14.60	4.40







KJA	Pattern Code					
		(mm)	(mm)	(mm)	(kg/roll)	(kg/m)
	KJA150	150	8	3530	5.10	1.44

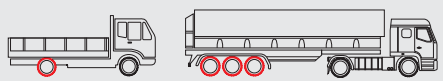





KG	Pattern Code					
		(mm)	(mm)	(mm)	(kg/roll)	(kg/m)
	KG180	180	14	3050	8.80	2.89
	KG194	194	15	3190	9.86	3.09

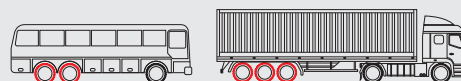





KM	Pattern Code					
		(mm)	(mm)	(mm)	(kg/roll)	(kg/m)
	KM152	152	11	4942	10.43	2.17
	KM180	180	14	3100	9.15	2.95
	KM193	193	14	3250	10.50	3.23
	KM210	210	15	3285	12.00	3.65
	KM250	250	20	3490	20.20	5.79

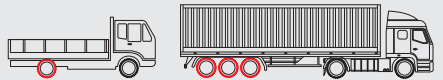







KKK	Pattern Code	 (mm)	 (mm)	 (mm)	 (kg/roll)	 (kg/m)
	KKK193	193	14	3167	9.00	2.84







KS	Pattern Code	 (mm)	 (mm)	 (mm)	 (kg/roll)	 (kg/m)
	KS180	180	14	3100	8.55	2.76
KS193	193	15	3160	9.20	2.91	







KV	Pattern Code	 (mm)	 (mm)	 (mm)	 (kg/roll)	 (kg/m)
	KV193	193	15	3195	9.87	3.09

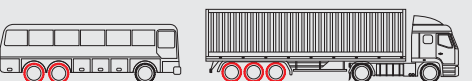





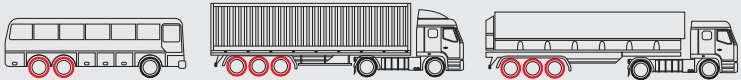

KVV	Pattern Code	 (mm)	 (mm)	 (mm)	 (kg/roll)	 (kg/m)
	KVV220	220	16	3280	12.20	3.72









KM.X.4	Pattern Code	 (mm)	 (mm)	 (mm)	 (kg/roll)	 (kg/m)
		KM.X.4-194	194	15	3160	9.55
	KM.X.4-205	205	16	3270	11.37	3.48
	KM.X.4-215	215	16	3240	11.90	3.67









KBB	Pattern Code	 (mm)	 (mm)	 (mm)	 (kg/roll)	 (kg/m)
		KBB230	230	16	3300	13.65
	KBB250	250	16	3290	15.18	4.61



LG	Pattern Code	 (mm)	 (mm)	 (mm)	 (kg/roll)	 (kg/m)
		LG150	150	12	4840	9.80
	LG193	193	14	3165	8.97	2.83
	LG210	210	15	3260	11.40	3.50



KBC	Pattern Code	 (mm)	 (mm)	 (mm)	 (kg/roll)	 (kg/m)
		KBC152	152	12	4833	9.93



KT21

Pattern Code	(mm)	(mm)	(mm)	(kg/roll)	(kg/m)
KT21-210	210	15	3390	12.70	3.90
KT21-220	220	15	3365	13.14	3.90
KT21-230	230	15	3370	13.60	4.04
KT21-240	240	15	3372	14.04	4.16
KT21-250	250	15	3425	15.03	4.39

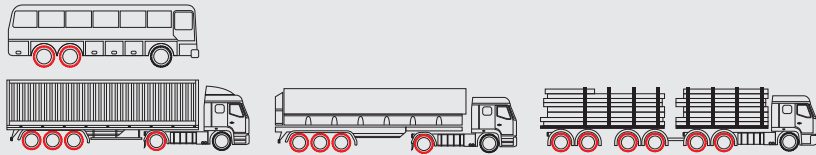

KD71

Pattern Code	(mm)	(mm)	(mm)	(kg/roll)	(kg/m)
KD71-230	230	15	3393	13.42	3.96
KD71-240	240	15	3391	13.73	4.05
KD71-250	250	15	3398	14.92	4.39



KT22

Pattern Code	(mm)	(mm)	(mm)	(kg/roll)	(kg/m)
KT22-295	295	13	3440	17.20	5.00

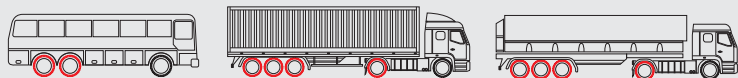

KD72

Pattern Code	(mm)	(mm)	(mm)	(kg/roll)	(kg/m)
KD72-210	210	14.5	3435	12.80	3.73
KD72-220	220	14.5	3400	13.20	3.88
KD72-230	230	14.5	3405	14.19	4.17
KD72-240	240	14.5	3430	14.87	4.34
KD72-250	250	14.5	3460	16.04	4.64

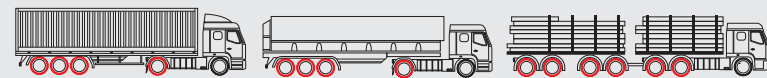

KD73	Pattern Code	(mm)	(mm)	(mm)	(kg/roll)	(kg/m)
	KD73-230	230	13	3390	13.20	3.89
KD73-240	240	13	3400	13.50	3.97	



KP41	Pattern Code	(mm)	(mm)	(mm)	(kg/roll)	(kg/m)
	KP41-240	240	15	3375	14.15	4.19
KP41-250	250	15	3395	14.62	4.30	
KP41-260	260	15	3380	15.22	4.50	







KP41s	Pattern Code	(mm)	(mm)	(mm)	(kg/roll)	(kg/m)
	KP41s-230	230	13	3300	12.10	3.67
KP41s-240	240	13	3310	12.50	3.78	
KP41s-250	250	13	3325	13.10	3.94	
KP41s-260	260	13	3304	13.60	4.12	



KP42	Pattern Code	(mm)	(mm)	(mm)	(kg/roll)	(kg/m)
	KP42-193	193	15	3190	10.16	3.18
KP42-240	240	18	3380	16.35	4.84	
KP42-250	250	18	3405	16.93	4.97	







KP43

Pattern Code	 (mm)	 (mm)	 (mm)	 (kg/roll)	 (kg/m)
KP43-210	210	15	3250	11.20	3.44
KP43-220	220	15	3240	12.33	3.81







KP44

Pattern Code	 (mm)	 (mm)	 (mm)	 (kg/roll)	 (kg/m)
KP44-205	205	16	3323	13.10	3.94
KP44-220	220	16	3310	13.90	4.20







KAA70

Pattern Code	 (mm)	 (mm)	 (mm)	 (kg/roll)	 (kg/m)
KAA70	320	26	3420	30.00	8.77



KAA

Pattern Code	 (mm)	 (mm)	 (mm)	 (kg/roll)	 (kg/m)
KAA320	320	26	3450	28.35	8.22



